

POWER & EFFICIENCY

INPUT POWER OPTIONS	AC 1PH 200-240V 60Hz AC 3PH 200-240V 60Hz AC 3PH 380-480V 60Hz		
MAXIMUM RATED CURRENT (amp)	7.8 - 6.5 A		4.1 - 3.4 A 2.4 - 2.0 A
POWER (hp)	1 HP BLDC Motor		
MAXIMUM SPEED (RPM)	95 RPM		
MAX AFFECTED AREA	113 ft Dia 12,769 sqft		

DIMENSIONS & WEIGHT

FAN DIAMETER	18 ft
FAN WEIGHT	183 lb (83 kg)

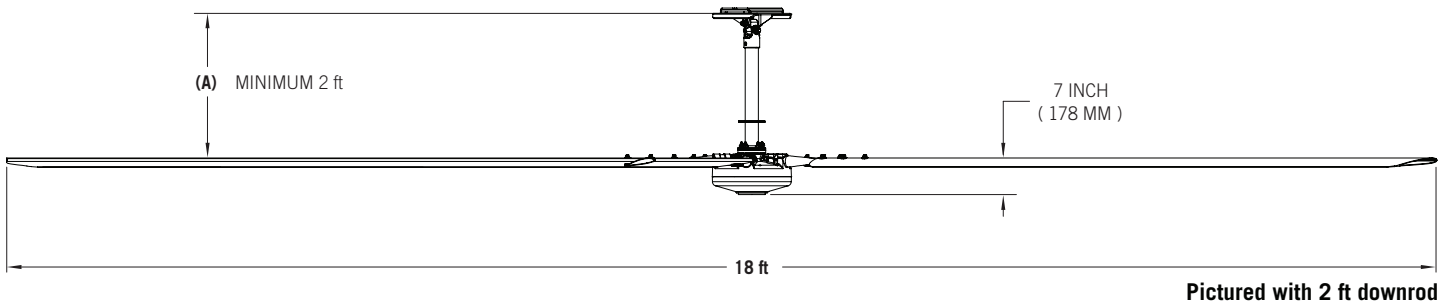

MOUNTING & SAFETY

MOUNTING OPTIONS	I-beam Glulam
DOWNROD (A)	Downrods available in 1 ft increments: 2 ft min., 10 ft max. Downrod length must be specified at time of order.
SAFETY FEATURES	Fan Retention System Airfoil Retention System Fire Relay

IN THE BOX

INCLUDED	Fan I-beam mount with pre-wired downrod Control panel Install manual Mounting hardware kit Communication Kit Guy wire kit
OPTIONAL	Additional cable lengths BMS Integration Glulam brackets 350, 500, 700E Series Controller Environmental Control Solution Fire Relay

WARRANTY & CERTIFICATIONS

CERTIFICATIONS	ETL/Intertek-certified to ANSI/UL 507 and CSA C22.2 No. 113 in North America "AMCA" Certified
WARRANTY ¹	Limited Lifetime Warranty

¹See complete warranty for details.

